

Model 3002 Digital Survey Meter

Ludlum Measurements

February 2022

Serial Number: 25023213 and Succeeding

Firmware: n21.1839 and Higher

Model 3002 Digital Survey Meter

Ludlum Measurements

February 2022

Serial Number: 25023213 and Succeeding

Firmware: n21.1839 and Higher



LUDLUM MEASUREMENTS, INC
501 OAK STREET, P.O. BOX 810
SWEETWATER, TEXAS 79556
325-235-5494, FAX: 325-235-4672

STATEMENT OF WARRANTY

Ludlum Measurements, Inc. warrants the products covered in this manual to be free of defects due to workmanship, material, and design for a period of twelve months from the date of delivery. The calibration of a product is warranted to be within its specified accuracy limits at the time of shipment. In the event of instrument failure, notify Ludlum Measurements to determine if repair, recalibration, or replacement is required.

This warranty excludes the replacement of photomultiplier tubes, G-M and proportional tubes, and scintillation crystals which are broken due to excessive physical abuse or used for purposes other than intended.

There are no warranties, express or implied, including without limitation any implied warranty of merchantability or fitness, which extend beyond the description of the face thereof. If the product does not perform as warranted herein, purchaser's sole remedy shall be repair or replacement, at the option of Ludlum Measurements. In no event will Ludlum Measurements be liable for damages, lost revenue, lost wages, or any other incidental or consequential damages, arising from the purchase, use, or inability to use product.

RETURN OF GOODS TO MANUFACTURER

If equipment needs to be returned to Ludlum Measurements, Inc. for repair or calibration, please send to the address below. All shipments should include documentation containing return shipping address, customer name, telephone number, description of service requested, and all other necessary information. Your cooperation will expedite the return of your equipment.

LUDLUM MEASUREMENTS, INC.

ATTN: REPAIR DEPARTMENT

501 OAK STREET

SWEETWATER, TX 79556

800-622-0828

325-235-5494

FAX 325-235-4672

REVISION HISTORY

REV	DESCRIPTION	DATE	BY
1	VALID	10/6/15	WJM
2	ECF #3951	1/13/16	WJM

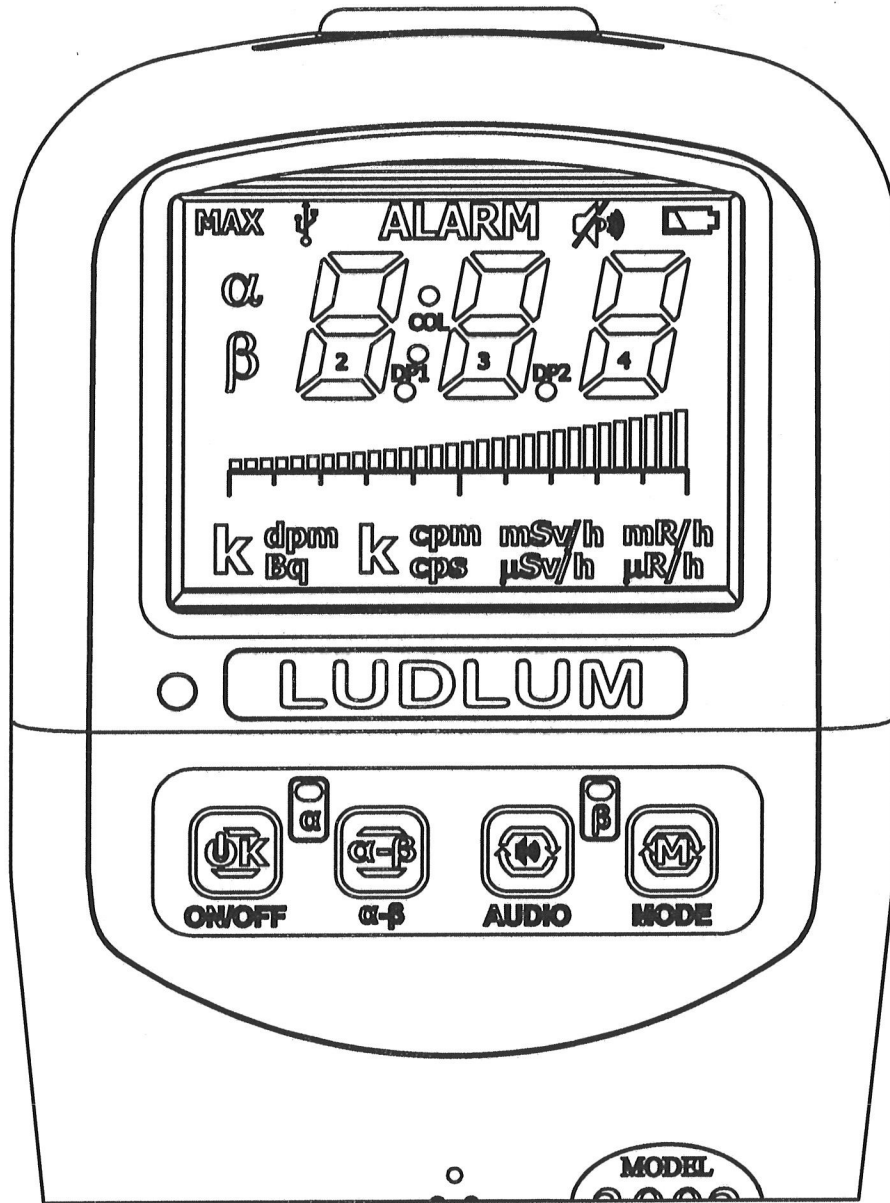

DWN	DATE	CHK	DATE	APP	DATE
WJM	1/13/16			WJM	5-26-16
DWG NUM: 4498-879				SCALE: 1:1	
TITLE M 3002 FRONT PANEL					
 LUDLUM MEASUREMENTS, INC. 501 OAK STREET SWEETWATER, TEXAS 79556			SERIES	SHEET	
			498	879K	

REVISION HISTORY

REV	DESCRIPTION	DATE	BY
1	VALID	10/6/15	WJM
2	ECF #3951	1/13/16	WJM

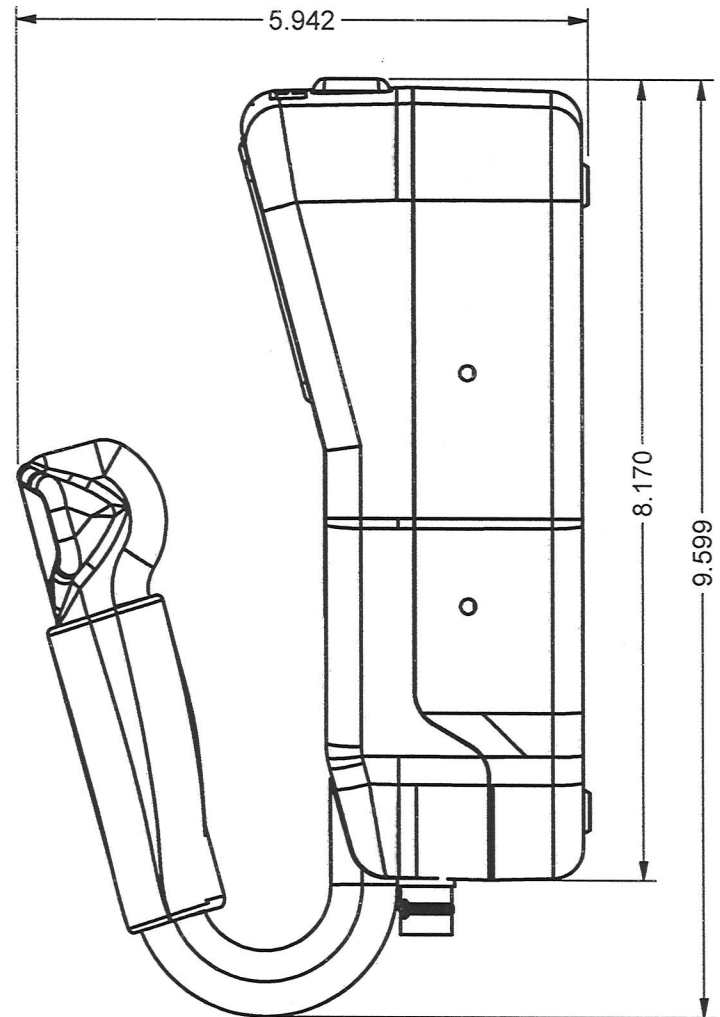
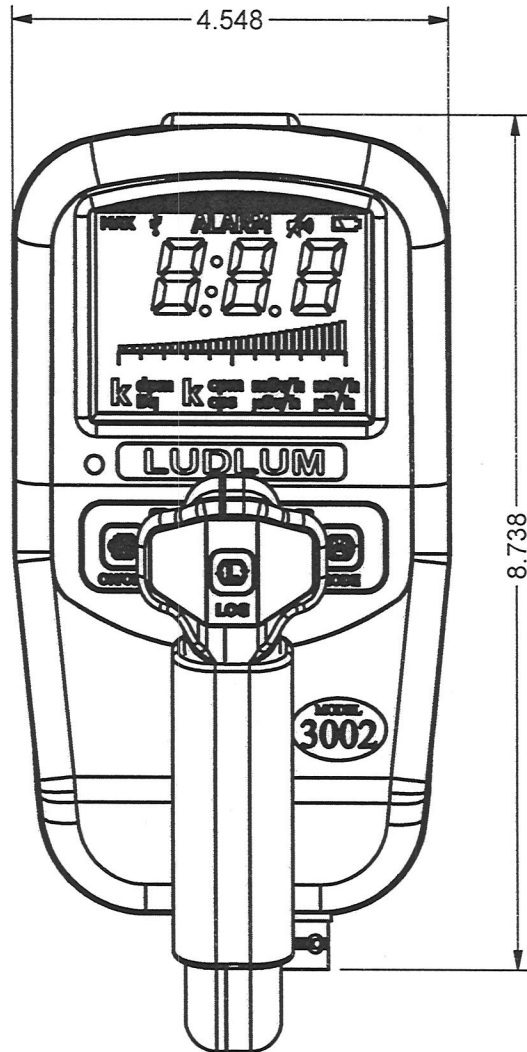

DWN	DATE	CHK	DATE	APP	DATE
WJM	5/26/16			WJM	5-26-16
DWG NUM: 4498-879				SCALE: 1:1	
TITLE M 3002 OVERALL DIMENSIONS					
 LUDLUM MEASUREMENTS, INC. 501 OAK STREET SWEETWATER, TEXAS 79556		SERIES	SHEET		
		498	879L		

CONTENTS

Contents	3
List of Figures	5
List of Tables	7
1 Introduction	9
2 Getting Started	11
2.1 Unpacking and Repacking	11
2.2 Battery Installation	11
2.3 Instrument Operational Test	12
2.3.1 Turning the Instrument On	12
2.4 Detector Failure Diagnostics	14
2.4.1 Detector Loss of Count	14
2.4.2 Detector Over Range	14
2.4.3 Detector Overload	15
2.5 Instrument Use And Controls	15
2.5.1 ON/OFF Button:	16
2.5.2 Alpha-Beta Button:	17
2.5.3 AUDIO Button:	17
2.5.4 MODE Button:	18
2.5.5 LOG Button:	18
2.6 RATE Mode Operation	19
2.7 MAX Mode Operation	20
2.8 COUNT Mode Operation	21
3 Specifications	25
4 Setup Mode	27
4.1 Setup Overview	27
4.2 Setup Parameters	28
4.3 Entering Setup Mode	29
4.4 Setup Mode Operation	30
4.5 Model 3002 List of Parameters (in order)	31
4.6 Setup Page 1	33
4.7 Setup Page 2	35
4.8 Setup Page 3	37
4.9 Setup Page 4	39
4.10 Setup Page 5	41
5 Datalogging	43
5.1 Datalogging Operation – Mode 1	43

5.2	Datalogging Operation – Mode 2	44
5.3	Data Log Operation	45
5.4	Format	45
6	Software	47
6.1	Connecting to Software	47
7	Advanced Features	49
7.1	Software Calibration Tools	49
7.2	Instrument Calibration	49
7.3	Other Device Data	49
7.4	Battery Life	50
7.5	Real-time Streaming	50
7.6	Button Mapping	50
7.7	CPS Offset	51
8	Safety Considerations	53
8.1	Environmental Conditions for Normal Use	53
8.2	Warning Markings and Symbols	53
8.3	Cleaning and Maintenance Precautions	54
9	Revision History	55
10	Recycling	57
11	Options	59
12	Standard Parts List	61
A	Auxiliary Communications	63
A.1	AuxCom Overview	63
A.2	Requirements	63
A.3	Usage	63
A.3.1	AuxCom Usage - Hot Key	63
A.3.2	AuxCom Usage - Pairing	64
A.4	Settings	66
A.4.1	AuxCom Setting - Mode	66
A.4.2	AuxCom Setting - Off Time	66
A.4.3	AuxCom Setting - Pwr Mode	67
A.4.4	AuxCom Setting - Write Protect	67
A.4.5	AuxCom Setting - Encryption	67
A.4.6	AuxCom Setting - Auto Mode Interval	68

LIST OF FIGURES

2.1	Startup Display (All Segments Shown)	12
2.2	Firmware Version Display	12
2.3	Battery Voltage Display	13
2.4	Startup Display Showing 189 Stored Data Records	13
2.5	Detector Loss of Count Display-Alpha (Display Will Flash)	14
2.6	Detector Over Range-Alpha (Display Will Flash)	15
2.7	Detector Overload Alarm (Display Will Flash)	15
2.8	RATE Mode Displaying Background Radiation Rate	20
2.9	MAX Mode Display With ALARM Indication	20
2.10	COUNT Mode Displaying COUNT Timer of 5 Minutes, 30 Seconds	23
4.1	Setup Page Selection Display (showing page 4-CAL)	30
5.1	Displaying Datalog Table Index of 12	44
5.2	Displaying Datalog Location ID Table Index of 36	44
A.1	Example – Device Selection In Lumic Linker App (iOS)	65
A.2	Example – Pairing	65
A.3	Example – Model 3000 series Found in Lumic Linker App (iOS)	65
A.4	Example – Entering PIN In Lumic Linker App (iOS)	65
A.5	Example – Lumic 2.0 Calibration Software	66

LIST OF TABLES

2.1	COUNT Mode Units and Result	22
4.1	Setup Parameters	29
4.2	Response Time Based on Count Rate	34
4.3	Units and Multipliers	36
4.4	Count Units and Multipliers	36
12.1	Standard Parts List	61
A.1	AuxCom Mode	66
A.2	AuxCom Auto Off Time	67
A.3	AuxCom Power on at Boot-up	67
A.4	AuxCom Write Protect	67
A.5	AuxCom Encryption	68
A.6	AuxCom Auto Mode Interval	68

INTRODUCTION

The Model 3002 is an ergonomic, lightweight instrument which is designed to be used for simultaneous alpha and beta radiation survey. The Model 3002 features the ability to measure radiation in count rate, exposure rate/dose, activity rate, time-averaged rates, and scaler counts. The Model 3002 utilizes an external radiation detector to detect alpha and beta radiation, typically either a scintillation or gas-proportional detector.

Three modes of operation are available for the Model 3002 – RATE, MAX, and COUNT.

It is possible to make the instrument operation even simpler by restricting the number of modes, for example just having the RATE mode available to the user. RATE mode operation will display the current counter activity rate. MAX mode is used to capture the highest count rate or activity rate detected – useful for finding a peak rate, or frisking when the display is not visible. The user can switch between alpha or beta (or alpha+beta) by simply pressing the Alpha-Beta (α - β) button. COUNT mode allows the user to perform a count for a predetermined time. Depending on the count units chosen, the result can be a scaler count (in counts or disintegrations), or a time-averaged rate (cpm, dpm, Bq, cps). The audio can be enabled during the COUNT mode, but long pressing the audio button allows the user to select between commonly used count times.

The instrument features a large backlit LCD (liquid crystal display), an easy, intuitive use keypad, and audio feedback. The unit body is made of lightweight but durable plastic. It is intended for outdoor use and can resist splashing water. The foam grip provides a comfortable, ergonomic grip but may be removed for ease of decontamination.

The display will be automatically back-lit if light levels are low or can be set to a user defined light level. The display back-light can also be configured for “Continuous On” operation. All available operational modes can be silent or utilize a “click” audio.

Setup of the instrument is accomplished through the front-panel buttons, or through Lumic 2 software available from Ludlum Measurements.

Front-panel setup can be disabled via the internal switch on the Model 3002 in order to protect settings from inadvertent changes. When the settings are protected, the user can view the settings or modify a limited number of settings as defined with the Lumic software. Using the Lumic software, the Model 3002 can be configured to allow changes to the alarms and or count time even when in protect mode.

The unit is operated with four alkaline AA batteries for operation from -20 to 50 °C (-5 to 122 °F). Battery life is approximately 750 hours (as low as 100 hours w/backlight always on) under normal usage. A low-battery indicator on the LCD warns when less than 16 hours of battery life remain.

The Model 3002 comes with the ability to log measurements to memory for later download. The optional Ludlum Lumic Datalog software is needed to download this memory, however. The unit can log up to 1000 alpha and beta measurements simultaneously, and it adds a date/time stamp to each measurement.

There are several options for the Model 3002 , including a headphone jack (for listening to clicks in noisy environments), a storage or shipping case to securely transport or store your instrument, and an optional set of rings to fasten a shoulder strap to the instrument for easier carrying.

The Ludlum Lumic Calibration software is also recommended for calibration of your instrument, since it allows for the reading/writing/printing of all the instrument parameters. It includes wizards that will assist in calibrating and plateauing detectors. After configuring the wizard for a specific detector, the wizard will automate much of the data collection and calculation required for calibration.

For more advanced use: See Appendix A for information on our Auxiliary Communications features, which allow the instrument to expand its capabilities with a variety of external devices through a standard serial interface.

GETTING STARTED

2.1 Unpacking and Repacking

Remove the calibration certificate and place it in a secure location. Remove the instrument and ensure that all of the items listed on the packing list are in the carton. Check individual item serial numbers and ensure calibration certificates match between instruments and detectors (if applicable). The Model 3002 serial number is located on a label on the front side of the unit.

To return an instrument for repair or calibration, provide sufficient packing material to prevent damage to the instrument during shipment. Every returned instrument must be accompanied by an Instrument Return Form, which can be downloaded from the Ludlum website at www.ludlums.com. Find the form by clicking the "Support" tab and selecting "Service Department" from the drop-down menu. Then choose the appropriate form located under the "Returned Goods Form" heading.

2.2 Battery Installation

A low-battery indicator appears at the top of the LCD when less than 16 hours of battery life remain. When this indicator is present, follow these steps to replace the four standard AA batteries:

1. Turn off power to the instrument.
2. Turn the instrument over so that the bottom of the instrument is facing up.
3. Use a straight, medium-sized screwdriver to turn the single screw on the battery cover one-quarter turn counter-clockwise.
4. Release and remove the battery cover.
5. Replace all four AA batteries.
6. Replace the cover and turn screw one quarter of a turn clockwise to secure.

2.3 Instrument Operational Test

Once this procedure has been completed, the instrument is ready for use.

2.3.1 Turning the Instrument On

Turn the instrument ON by pressing the ON/OFF button for about a second, and then releasing. The instrument should activate all the LCD segments and the audio. Observe the device during this time. If any LCD segments are missing, or audio fails to work, the device is in need of repair. Please refer to Figure 2.1.

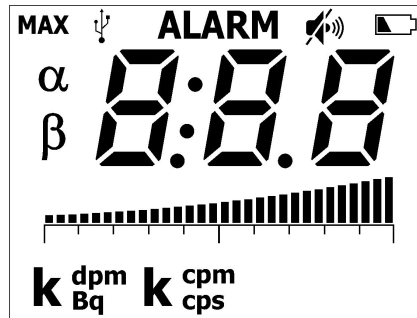

Figure 2.1: Startup Display (All Segments Shown)

The instrument then displays the firmware version. Please refer to figure below.



Figure 2.2: Firmware Version Display

Note: Firmware versions with Bq units are equipped with auxiliary communication.

Beginning with the n20 version firmware, the tick marks below the firmware number define the board generation, which will help with future firmware updates. Once n20 is installed, the user will no longer have to open the instrument to determine which version of the main processor board was used in the instrument. Instead, use the following table to determine which main processor board is installed in the instrument:

- 1 tick - 5498-901
- 2 ticks - 5519-063
- 3 ticks - 5519-270

- 4 ticks - 5519-797

The instrument then displays the battery voltage. Please see Figure below.

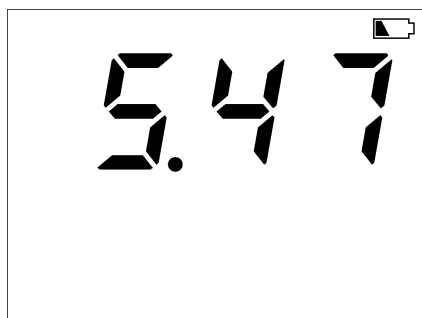

Figure 2.3: Battery Voltage Display

The instrument then displays the number of stored records if datalogging is enabled. Please refer to the figure below.

Note: The instrument may display "- - -" while it determines how many log records have been saved. This should take no longer than a few seconds.

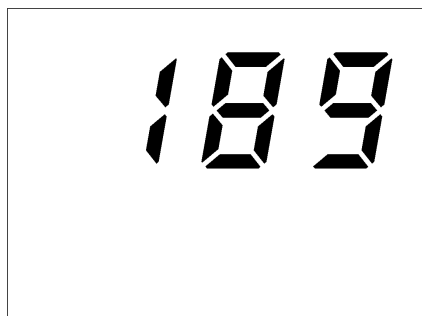

Figure 2.4: Startup Display Showing 189 Stored Data Records

The instrument will then move to normal operation, displaying the current rate (factory default: cpm). This boot-up process takes about 5 seconds.

Ensure that the low-battery indicator is not present. If the low-battery indicator is present, replace the batteries as soon as possible. Should the instrument detect a battery voltage that is high enough to power on, but too low to safely operate, the display will blank and the low-battery icon will flash. Normal operation will not be available until the batteries have been replaced. Under extreme low-battery conditions, be aware that the unit may not even turn on or may turn itself off abruptly.

To assure proper operation of the instrument and detector(s) between calibrations, an instrument operational check including battery test and instrument test should be performed at least daily or prior to use, whichever is less frequent. A reference reading (or readings) with a dedicated check source should be obtained with the detector(s) in a constant and reproducible manner at the time of calibration or at the time the instrument is received in the field.

If at any time the instrument fails to read within 20% of the reference reading when using the dedicated check source, it should be removed from service and sent to a calibration facility for recalibration and/or repair. If desired, multiple readings may be taken at different distances and/or with different sources so that other scales are checked.

Example of a Check Source reading:

Check Source # _____ Rate _____ Units _____

2.4 Detector Failure Diagnostics

Note that the Model 3002 has its own diagnostic tests to ensure that the detector is functioning correctly.

2.4.1 Detector Loss of Count

If the detector stops detecting radiation for a settable number of seconds, the Model 3002 will flash the display and the LED for the specific radiation type to indicate a fault while emitting an audible alarm. If the detector stops detecting alpha or beta radiation for a settable number of seconds (loss of counts), the failing type of radiation will flash a zero reading for the currently selected radiation type, and the alpha+beta channel will flash the current value. This indication is common if the unit is powered up without a detector connected. If this indication is observed with a connected detector, remove the unit from service and have it evaluated by a qualified repair and calibration technician.

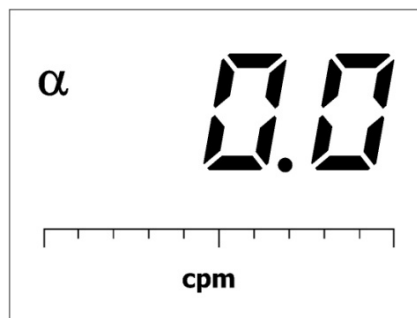

Figure 2.5: Detector Loss of Count Display-Alpha (Display Will Flash)

2.4.2 Detector Over Range

If the detector is exposed to high levels of radiation or has an internal malfunction that causes it to count high or excessively, the unit flashes the maximum display value for the currently selected radiation type as a warning. Additionally, the ALARM icon is displayed at the top of the screen, an audio alarm sounds (which can be silenced by a long press of the ON/OFF button), and the device status OVERRANGE is streamed or logged. The user should ensure whether this condition is being caused by a high radiation field, by a shorted cable, or by internal malfunction. If a Maximum Display parameter is set, then it is possible for the display to flash the Maximum Display value under this condition.

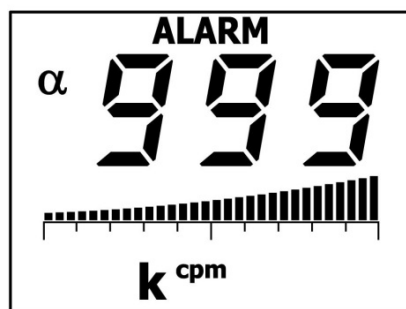

Figure 2.6: Detector Over Range-Alpha (Display Will Flash)

2.4.3 Detector Overload

As another diagnostic test, the Model 3002 monitors the HV supply's detector current. A current overload threshold can be set via Setup Mode or Lumatic Software. (A setting of 0 or 999 disables this alarm.) In general, this alarm setting can be used to detect when there is some detector failure, a light leak, a cable failure, or a possible high level of radiation. When this alarm is triggered, the LCD will display "OL" in place of the numerical values, and an alarm tone will sound. Once the detector current goes below the threshold, the Model 3002 will return to normal operation.



Figure 2.7: Detector Overload Alarm (Display Will Flash)

2.5 Instrument Use And Controls

With four front-panel buttons and one handle button (as seen in front-panel drawing in front of manual), the Ludlum Model 3002 is simple and easy to use with minimal training required. Default operation is RATE mode, and the display shows the current count rate. Pressing the $\alpha - \beta$ button will switch between alpha and beta and alpha+beta rate units. Pressing the MODE button will switch the instrument to MAX mode, which will display the highest count rate detected. Pressing the MODE button again will switch it to COUNT mode, which will display the COUNT timer. Note that either or both of the MAX and COUNT modes can be locked out in the setup process. Each button may be pressed and held for a predetermined length of time, signified by instrument beeps, to access unique instrument features. As the button is pressed, the instrument will beep to indicate the user has reached a new level of button access.

- A short press and release, less than 1/2 second and before any instrument beeps occur, will activate the first level of button operation. When the button is released, a single beep will occur as an acknowledgement.

- A long press, greater than 1/2 second but less than 2 seconds, will force the instrument to emit one beep. Release the button after the beep to activate the second level of operation.
- An extra-long press and release, greater than 2 seconds and after the second instrument beep, will activate the highest level of operation. After the second beep, the button may be released.

By default, the majority of functions are assigned to short presses of the buttons.

2.5.1 ON/OFF Button:

Used to power the Model 3002 ON and OFF

- Power On: Press for approximately one second and release.
- Power Off: Press and hold for approximately five seconds. The display will show a 3, 2, 1 countdown after the second beep. Releasing the ON/OFF button during shutdown will return the device to the previous state of operation. At completion of the shutdown count, the LCD will go blank (unless a USB cable is connected in which case the USB icon will flash).

Short Press (press and release before one beep):

- During normal operation, it will acknowledge/silence alarms in any mode of operation.
- Change Log Location selected position (If data logging mode 2 is enabled).
- Will move selection position in the device menu.

Long Press (press and release after one beep):

- In RATE mode, it will reset the currently displayed rate if the user has permission (permission set from Lumic 2.0 software). The minimum display will be shown before returning to the count/activity rate.
- In MAX mode, it will reset the current MAX value.
- In COUNT mode, it will:
 - If COUNT mode is ready: It will initiate the count.
 - If COUNT mode is in progress: It will stop the current count and reinitialize the instrument to begin the next count.
 - If COUNT mode is complete: It will reset the count mode and reinitialize the instrument to begin the next count.

Extra-Long Press (press and release after two beeps):

- Currently has no effect.

2.5.2 Alpha-Beta Button:

In default operation, the display shows the current count/activity rate using the Primary radiation type. A short press of the $\alpha - \beta$ button will switch between alpha, beta and alpha + beta units.

Short Press (press and release before one beep):

- Used to switch between alpha and beta and alpha+beta in all three modes. Note that the Channel Display Selection parameter can limit this button to fewer choices.
- Used to advance through the device menu.

Long Press (press and release after one beep):

- Toggles COUNT mode display between count timer and count readings.

Extra-Long Press (press and release after two beeps):

- Enables/disables the Auxiliary Communications in conjunction with the Mode button.

2.5.3 AUDIO Button:

The Audio button's primary function is to adjust the audio level of the instrument.

Short Press (press and release before one beep):

- During normal operation, it will increment the audio through available volume levels which include mute and high.

Long Press (press and release after one beep):

- In Count mode with the timer ready, will increment through the available count times.
 - User defined.
 - 0 (minimum display) or Continuous Count
 - 6 seconds (0:06)
 - 30 seconds (0:30)
 - One minute (1:00)

- Two minutes (2:00)
- 5 minutes (5:00)
- 10 minutes (9:60)

Extra-Long Press (press and release after two beeps):

- Device Menu: When viewing the detector current overload setpoint, this will switch the display between the live current reading and the set point value.

2.5.4 MODE Button:

The Mode button's primary function is to switch between available enabled modes.

Short Press (press and release before one beep):

- During instrument initialization and within 4 seconds after the power-up screen, three short presses of the MODE button will place the instrument into setup mode. Once the instrument is displaying normal operation, and 4 seconds have passed, the button can be used to advance to the next available mode.
- Used to advance between the three operating modes: RATE, MAX, and COUNT. While RATE must always be enabled, any combination of MAX and COUNT modes may be disabled from use.

Long Press (press and release after one beep):

- Currently has no effect.

Extra-Long Press (press and release after two beeps):

- Enables/disables the Auxiliary Communications in conjunction with the $\alpha - \beta$ button.

2.5.5 LOG Button:

By default, the LOG button's primary function is to log an event or initiate a count in COUNT mode which will be logged upon completion of the count (if data logging is enabled); however, the functionality of the LOG button can be configured in software to permit multiple functions to be assigned to the LOG button. This is referred to as Button Mapping. For more information on Button Mapping, please refer to Section 7.6. The default operation of the LOG button is as follows:

Short Press (press and release before one beep):

- In RATE mode, it will log the current rate reading if datalogging is enabled.

- In MAX mode, it will log the current MAX value if datalogging is enabled.
- In COUNT mode, it will:
 - If COUNT mode is ready: Initiate a count. Upon completion, the result will be logged if datalogging is enabled.
 - If COUNT mode is in progress: Button has no effect.
 - If COUNT mode is complete: Button will log the current result.
- If datalogging in Mode 2 and a log event has been initiated, the button is used to accept the current location ID.

Long Press (press and release after one beep):

- Currently has no effect by default.

Extra-Long Press (press and release after two beeps):

- Currently has no effect by default.

2.6 RATE Mode Operation

In RATE mode, the current count/activity rate will be displayed. The maximum displayable value, regardless of units, is 999 k.

If an alarm is not in progress, a long press of the ON/OFF button will reset the averaged rate before releasing the button. The Reset feature must be enabled through Lumatic 2 Calibration software.

A short press of the $\alpha - \beta$ button will switch the displayed value between the Alpha, Beta, and Alpha + Beta Units. Note Display modes may be limited through software.

A short press of the AUDIO button will toggle click audio between Off and On (Hi).

If an alarm condition is present, a short press of the ON/OFF button will acknowledge and turn off the alarm audio. Under an alarm condition, the ALARM display indicator will be activated. There are two user settable alarms for both alpha and beta. If both alarms for a particular radiation type are set, the first alarm will activate beeping alarm audio and a flashing ALARM display indicator; If only one alarm is set or the second alarm is triggered, both the alarm audio and the ALARM display indicator are continuous. Alarms are non-latching in RATE mode.

If other operational modes are available, a short press of the MODE button will move to the next available operational mode.

By default, a short press of the LOG button, if datalogging is enabled, will log the currently displayed rate.

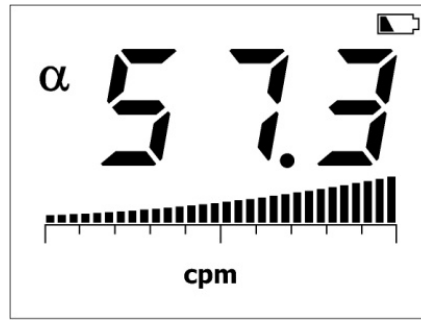

Figure 2.8: RATE Mode Displaying Background Radiation Rate

2.7 MAX Mode Operation

While in MAX mode, the highest detected count rate (since MAX mode was selected) is displayed. The word MAX will be displayed when in MAX mode. A short press of the $\alpha - \beta$ button will switch the displayed value between the alpha, beta, and alpha+beta.

A short press of the AUDIO button will toggle click audio between Off and On (Hi).

Under a non-alarm or alarm condition, a long press of the ON/OFF button will reset the display.

If an alarm condition is present, a short press of the ON/OFF button will acknowledge and turn off the alarm audio. Under an alarm condition, the ALARM display indicator will be activated. There are two user settable alarms for both alpha and beta. If both alarms for a particular radiation type are set, the first alarm will activate beeping alarm audio and a flashing ALARM display indicator; If only one alarm is set or the second alarm is triggered, both the alarm audio and the ALARM display indicator are continuous. Alarms are latching in MAX Mode. Under an alarm condition, the ALARM display indicator will remain on until the display is reset.

If other operational modes are available, a short press of the MODE button will move to the next available operational mode.

By default, a short press of the LOG button, if datalogging is enabled, will log the currently displayed MAX value.

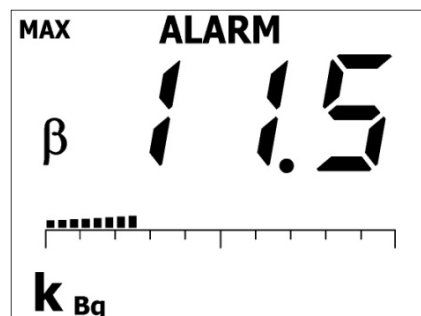

Figure 2.9: MAX Mode Display With ALARM Indication

2.8 COUNT Mode Operation

When entering COUNT Mode from another operational mode, the currently selected COUNT radiation type will be displayed for approximately one second. The purpose of COUNT mode is to count for a predetermined amount of time, and to display the results on the display. Pre-defined count times of 6 seconds, 30 seconds, 1 minute, 2 minutes, 5 minutes, and 10 minutes are available as well as a user-defined count time and continuous counting operation (count time displayed as 0 or the minimum display). The maximum user-defined count time is 600 seconds or 10 minutes (9:60). The maximum displayable value, regardless of units, is 999 k.

Count mode operation is very flexible, depending on the units chosen. A common choice is for the count mode to just perform a scaler count for a specified time, with a resulting answer in counts (equaling detected radiation events). There are three different options for COUNT mode, which can be set through software.

Go to “Cnt Display Mode” in the Dev tab. Select the desired option:

- **Timer:** Will only show the countdown timer while the timer is active (default selection).
- **Readings:** Will only show the current gathered reading.
- **Timer/Readings:** Will cycle between showing the countdown timer and the current reading.



By default, a short press of the LOG button will start a count and automatically log the result if datalogging is enabled. An extra-long press of the $\alpha - \beta$ button during the count will toggle the display between the timer and reading.

Adjusting Dev Cnt Audio Mode will enable or disable the click audio during a COUNT.

- **Off** - always off
- **On** - always on
- **W/Count** - audio is only enabled during an active count



If a result in terms of activity is desired, the scaler count can also be in units of "d" or disintegrations. But if the count units are chosen to be cpm or cps, then the resulting answer is an averaged count rate over the time interval. Similarly, if count units of Bq or dpm are chosen, the resulting answer is an averaged disintegration rate.



If the user desires the instrument to show results in terms of disintegrations/area (eg. dpm/100 cm²), then the instrument should be configured for dpm and the appropriate factor should be placed in the Efficiency parameter.

The following tables lists the possibilities:

UNITS	RESULT
c	counts per count time
d	disintegrations per count time
cpm, cps	count rate averaged over the count time
dpm, Bq	disintegration rate, averaged over the count time

Table 2.1: COUNT Mode Units and Result

In COUNT mode, operation depends on the current state of the Count Timer.

When the Count Timer is Ready:

- The display will show the Count Time.
- A short press of the $\alpha - \beta$ button will switch between the alpha, beta, and alpha+beta displays. The newly selected Count Units will be displayed for approximately one second, and the display will then return to the Count Timer.
- A long press of the ON/OFF will initiate a count but will not log the results upon completion.
- A long press of the Audio button will change the count time to the next available time.
- If other operational modes are available, a short press of the MODE button will move to the next available operational mode.
- By default, a short press of the LOG button will initiate a count and log the displayed result upon completion, if datalogging is enabled.

When the Count Timer is Active:

- The display will show either Count Time (default), both Count Time and Counts, or just Counts, depending on Device Count Display Mode.
- If needed, a long press of the ON/OFF button will stop the count and reset the Count Timer (results will not be logged if previously requested).
- Click audio, if enabled, can be adjusted by a short press of the AUDIO button.
- If an alarm condition occurs, the ALARM display indicator will turn on, and the Alarm audio will sound as soon as the count is complete. (If the count unit is an averaged rate, it is possible for the ALARM icon to come on during the count, but if the averaged rate falls below the alarm threshold by the end of the count, no ALARM will be active.)

- If other operational modes are available, a short press of the MODE button will cancel the current Count Timer and move to the next available operational mode.
- By default, the LOG button is unused during a count.

When the Count Timer has Finished:

- The display will show either the accumulated total for c, or d, or the timed ratemeter average for cps, cpm, dpm, or Bq.
- If datalogging is enabled and logging the count results was previously requested, the results will be logged to the log buffer.
- A short press of the $\alpha - \beta$ button will switch between the alpha, beta, and alpha+beta displays.
- a long press of the ON/OFF button will reset the Count Timer and initialize for a new count.
- If an alarm condition occurred during the Timed Count, a continuous audio tone will sound as the ALARM display indicator will already be on. To acknowledge and turn off the continuous tone alarm audio, a short press of the ON/OFF button is required. To clear the alarm condition and reset the Count Timer, a long press of the ON/OFF button is required.
- If other operational modes are available, a short press of the MODE button will move to the next available operational mode.
- By default, a short press of the LOG button will log the current display.

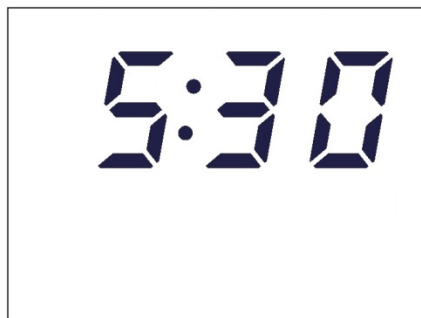

Figure 2.10: COUNT Mode Displaying COUNT Timer of 5 Minutes, 30 Seconds

SPECIFICATIONS

Detector: alpha beta scintillator or gas proportional

HV Range: 400-2200 Vdc

Beta Threshold Range: -2 to -99.9 mVdc, measured by Ludlum Model 500 Series Pulser.

Beta Window Range: -2 to -350 mVdc, measured by Ludlum Model 500 Series Pulser.

Alpha Threshold Range: -2 to -500 mVdc, measured by Ludlum Model 500 Series Pulser.

Alpha Window Range: -2 to -500 mVdc or wide open, measured by Ludlum Model 500 Series Pulser.

Resolving Time: approximately 5 μ sec as defined by IEC 60325

Response Time: user-selectable from 1 to 60 seconds, auto-response rate of fast or slow

Alarms: two adjustable count rate, exposure/dose, and count alarm setpoints adjustable over the display range

Overload Protection: high count rate saturation protection designed to prevent the false display of lower count rates

Zero Protection: after a user-settable number of seconds, typically 60 seconds, of no pulses from the detector, the alarm audio will be triggered

Dead Time Correction: employs first and second order corrections for extended performance

Overrange: if the reading should exceed the predefined detector range, the instrument will flash a maximum reading and trigger an audio warning

LCD Display: 3-digit LCD with large 20 mm (0.8 in.) digits, (k)cps, (k)cpm, (k)Bq, (k)dpm, (μ)(m)R(/h), (μ)(m)Sv(/h), low-battery indicator, MAX, ALARM, AUDIO, α , and β

Display Range:

- 0.0 cps to 99.9 kcps

- 0.00 cpm to 999 kcpm
- 0.00 Bq to 99.9 kBq
- 0.00 dpm to 999 kdpm

Backlight: built-in ambient light sensor automatically activates low-power LED backlight or backlight level may be user defined, unless internal dip switch is set to continuous-on (will reduce battery life)

User Controls:

- ON/OFF – extra-long press to turn ON, short press to acknowledge alarms, extra-long press plus 3 seconds to turn OFF
- $\alpha - \beta$ – short press changes between alpha, beta, and alpha+beta measurements
- AUDIO - short press to adjust audio level, Long press in COUNT mode allows for selection of alternate count times
- MODE – short press alternates between available modes: RATE (displays count rate), MAX (captures peak rate), and COUNT (captures rate or dose readings for a user-selectable count time from 0 to 10 minutes)
- LOG - short press to log current display (or initiate count in COUNT mode)

Audio: approximately 4.5kHz, click audio greater than 65 dB at 0.6 m (2 ft), alarm audio greater than 72 dB

Headphone Jack (optional): 1/8 inch stereo jack for use with headphones for audio output. It will be located to the left of the instrument handle.

Power: four alkaline “AA” batteries

Battery Life: approximately 750 hours (as low as 100 hours w/backlight always on) of operation, 16-hour low-battery warning

Maximum Current: 65 mAdc

Construction: high-impact plastic with water-resistant rubber seals and separate battery compartment

Temperature Range: -20 to 50 °C (-5 to 122 °F), may be certified for operation from -40 to 65 °C (-40 to 150 °F)

Environmental Rating: NEMA (National Electrical Manufacturers Association) rating of 5 or IP (Ingress Protection) rating of 53

Size: 16.5 x 11.4 x 21.6 cm (6.5 x 4.5 x 8.5 in.) (H x W x L)

Weight: 0.9 kg (1.6 lb) (excluding detectors and clips)

SETUP MODE



Only advanced users or administrators should consider changing any of the parameters in the following section. Incorrect settings could jeopardize the safety of users depending on this instrument.

4.1 Setup Overview

Your instrument has been shipped from Ludlum Measurements only after passing electronic checkout, a 24-hour burn-in process, and a careful calibration process. Calibration papers are supplied with each instrument shipped from Ludlum Measurements.

Recalibration should be accomplished after a predetermined calibration frequency (Ludlum Measurements, Inc. recommends no more than a one-year interval), or when the operation of the instrument is suspect or maintenance has been performed on the instrument. Recalibration is not normally required following instrument cleaning or battery replacement. While recalibration does not require any special tools or software to perform, Lusic software available through Ludlum Measurements, Inc. will greatly ease calibration, especially when second-order deadtime correction (extended calibration) is being utilized. As a result, the use of Lusic software is highly recommended.

Ludlum Measurements offers a full-service repair and calibration department. Not only do we repair and calibrate our own instruments, we also service most other manufacturers' instruments. Calibration procedures are available upon request for customers who choose to calibrate their own instruments.



Ludlum Measurements, Inc. recommends recalibration at intervals no greater than one year, assuming that regular operational checks are performed. Check the appropriate local, state, and federal regulations to determine required recalibration intervals.

4.2 Setup Parameters

Setting	Setup Parameter	Default Value	Notes
P1-1	High Voltage Setpoint	900	Volts
P1-2	Overload Threshold	999	Value
P1-3	Response Time	0	Enable Auto Response
P1-4	Auto Response Rate	S	Slow Auto Response
P1-5	Operational Modes	0	All Modes Available
P1-6	User Defined Count Time	0:00	Continuous Count
P1-7	Auto Shutdown Time	0	Hours (0-Disabled)
P1-8	Backlight Threshold	LO	Most Sensitive
P2-1	Unit 1 - RATE/ MAX Units and Minimum Display	000 cpm	
P2-2	Unit 1 - RATE/ MAX Units Maximum Display	999 kcpm	
P2-3	Unit 1 - COUNT Units and Minimum Display	000 c	
P2-4	Unit 1 - Channel Display Selection	0	α , β , $\alpha+\beta$ Displays Available
P3-1	Unit 2 - α Efficiency	20.0	Efficiency %
P3-2	Unit 2 - α Pulser Threshold	120	Millivolts
P3-3	Unit 2 - α Pulser Window	999	Millivolts
P3-4	Unit 2 - α RATE/ MAX Mode Alarm	5.00 kcpm	000 = disabled
P3-5	Unit 2 - α COUNT Mode Alarm Point	5.00 kc	000 = disabled
P3-6	Unit 2 - α Loss of Count Time	600	Seconds
P4-1	Unit 2 - β Efficiency	15.0	Efficiency %
P4-2	Unit 2 - β Pulser Threshold	3.5	Millivolts
P4-3	Unit 2 - β Pulser Window	30.0	Millivolts
P4-4	Unit 2 - β RATE/ MAX Mode Alarm	5.00 kcpm	000 = disabled
P4-5	Unit 2 - β COUNT Mode Alarm Point	5.00 kc	000 = disabled

Setting	Setup Parameter	Default Value	Notes
P4-6	Unit 2 - β Loss of Count Time	60	Seconds
P5-1	Datalogging Mode	1	Mode 1
P5-2	Real Time Clock Month	1	
P5-3	Real Time Clock Day	7	
P5-4	Real Time Clock Year	14	2014
P5-5	Real Time Clock Hour	16	24-Hour Mode
P5-6	Real Time Clock Minute	30	
P5-7	Real Time Clock Second	00	

Table 4.1: Setup Parameters

4.3 Entering Setup Mode

To enter Setup Mode, power down the Model 3002 then turn the unit back ON. When the instrument has begun normal operation, three short presses of the MODE button will place the instrument into Setup mode.

Entry to Setup Mode can be confirmed when the numeric portion of the display shows P-1, indicating the first setup page is selected. If you simply wish to view the parameters, select the desired Setup Page by a short press of the MODE button. A short press of the $\alpha - \beta$ button will advance through the parameters available on the selected Setup Page. To return to normal operation, advance back to the Setup Page selection by pressing the $\alpha - \beta$ button for at least a half second. Pressing the $\alpha - \beta$ for at least a half second again will exit, or holding the $\alpha - \beta$ button for approximately 5 seconds will exit from anywhere in the menu.



If the menu is not exited properly, any changes made will not be saved.

SETUP PROTECT: By default, the Model 3002 is shipped with DIP Switch 2 in the OFF (back) position and all available Model 3002 parameters may be modified in Setup mode. To protect the Model 3002 from changes in Setup mode, open the instrument, by removing the six screws on the bottom of the can, and slide DIP Switch 2 (the rightmost switch) to the ON (forward) position to activate Setup Protect Mode.



The dipswitch has a plastic cover, which protects the switch during manufacturing. This plastic cover is left on the dipswitch after assembly and is not removed until the dipswitch is needed. If the plastic cover still remains on the dipswitch, please remove the cover before changing the switch settings.



With the DIP Switch 2 in the ON position, setup mode may be entered through the front panel, and any parameter may be viewed, but changes cannot be made.

DISPLAY BACKLIGHT ‘Continuous On’: The Model 3002 display backlight can be set to remain on continuously during operation. Follow the steps from **SETUP PROTECT** to access the DIP switch but change DIP Switch 1 for display backlight selection. Setting DIP Switch 1 to the ON (forward) position will configure the display backlight to remain on during operation. Set DIP Switch 1 to the OFF (back) position, and the display will be backlit only when light levels are low.



Setting the display backlight for continuous-on operation can result in reduced battery life. The backlight can be configured to always be off as well through the device menu or Lumatic 2.0 Calibration Software.

4.4 Setup Mode Operation

Once the Model 3002 is in Setup mode, setup page selection will be displayed on the LCD and the Page number will be blinking indicating it as the selected item. The number of available parameters per Setup Page will be displayed using the graph where the number of segments indicates the number of parameters. Short press the MODE button to choose the Setup Page you are interested in. Once the desired Setup Page is shown, short press the $\alpha - \beta$ button to cycle down to the first parameter of that Setup Page. Further short presses on the MODE button will cycle down through the parameters for that page. Extra-long-pressing the $\alpha - \beta$ button will go back up to the Setup Page. Extra-long pressing again will exit the Setup Mode.



Figure 4.1: Setup Page Selection Display (showing page 4-CAL)

To exit more quickly, press and hold the $\alpha - \beta$ button, no matter what parameter is shown, will walk the user through all previous Setup Menu levels until the instrument returns to normal operation.

When you get to a parameter that you want to change, use the MODE button to make the change. If numbers are displayed on the parameter, the MODE button will increment the numbers. Otherwise, the MODE button will cycle through the available settings. When you have adjusted the parameter setting to your desired number or setting, extra-long press the $\alpha - \beta$ button. This will save the change and send you back up one screen to the page param-

eters. If more than one parameter can be changed on the page, short press the ON/OFF to advance through the available parameters then used the MODE to change the parameter.

For example:

α Rate Mode Alarm Value to 150 cpm.

Enter the Setup Menu.

- Use the MODE button to advance to P-3.
- Press the $\alpha - \beta$ button to enter the menu.
- Press the $\alpha - \beta$ button to get to the fourth of the six menu items. This is the parameter setting for the “ α RATE/MAX Mode Alarm Point.”
- Press the ON/OFF button to advance to the tens digit.
- Press the MODE button to increment the value to 5.
- Press the ON/OFF button to advance to the hundreds digit.
- Press the MODE button to increment the value to 1.
- Press the ON/OFF button to advance to the decimal point.
- Press the MODE button to until no decimal is displayed.
- Press the ON/OFF button to advance to the multiplier.
- Press the MODE button to until cpm is displayed.
- Press and hold the $\alpha - \beta$ button until the instrument returns to normal operation.

The list below shows the setup pages and the parameters in order, on each page.

4.5 Model 3002 List of Parameters (in order)

Page 1

- High Voltage Setting
- Overload
- Response Time
- Auto-Response Rate
- Operational Modes
- Count Time

- Auto Shutdown Time
- Backlight Threshold

Page 2

- RATE/MAX Units and Minimum Display
- RATE/MAX Units Maximum Display
- COUNT Units and Minimum Display
- Channel Display Selection

Page 3

- Alpha Efficiency
- Alpha Pulser Threshold
- Alpha Pulser Window
- Alpha RATE/MAX Model Alarm Point
- Alpha Count Mode Alarm Point
- Alpha Loss of Count Time

Page 4

- Beta Efficiency
- Beta Pulser Threshold
- Beta Pulser Window
- Beta RATE/MAX Model Alarm Point
- Beta Count Mode Alarm Point
- Beta Loss of Count Time

Page 5

- Datalogging Mode
- Real Time Clock Month
- Real Time Clock Day

- Real Time Clock Year
- Real Time Clock Hour
- Real Time Clock Minute
- Real Time Clock Second



Parameters on Page 5 are not user editable using the instrument Setup Mode. To edit these parameters, please use the Ludlum Lumic Calibration or Lumic Datalogging Software.

4.6 Setup Page 1

High Voltage Setting (Default 900 Volts)- A short press of ON/OFF to select the value to adjust, and MODE to adjust the value. Value is in Volts. Available values are:

- Ones Place (0-9)
- Tens Place (0-9)
- Hundreds Place (0-9)
- k Multiplier (on/off)



k multiplier also activates left-most decimal point. If k multiplier is used, Hundreds Place value is limited to 0, 1, and 2.

Overload (Default 999) - A short press of ON/OFF to select the value to adjust, and MODE to adjust the value. Setting the Overload value to 0 or 999 disables the Overload Alarm. Available values are:

- Ones Place (0-9)
- Tens Place (0-9)
- Hundreds Place (0-9)

A long press (at least a half second) of the AUDIO button will cause the display to show the actual live current reading. Repeating this process will return you back to the overload threshold setpoint.

Response Time (Default 0 - auto) – A short press of ON/OFF to select the value to adjust, and MODE to adjust the value. Setting the Response Time to a fixed value is useful primarily when performing surveys to a fixed MDA (Minimum Detectable Activity) level. Setting the

Response Time to 0 will enable the Auto-Response mode for the Model 3002 (see the next parameter). Available values (in seconds) are:

- Ones Place (0-9)
- Tens Place (0-6, 6 forces max Response Time of 60)

Auto-Response Rate (Default S) - A short press of MODE to to select Fast (F) or Slow (S). When operating in Auto-Response mode, the Model 3002 will vary the Response Time based on the Auto-Response Rate selected (Fast or Slow) and the current Count Rate. The following table shows the response time for different count rates when these auto response modes are chosen:

Count Rate	Auto Response Time - Fast (Seconds)	Auto Response Time - Slow (Seconds)
Less than 3kcpm (50cps)	10.5	21
Between 3 kcpm and 4 kcpm (67 cps)	8.4	16.8
Between 4 kcpm and 6 kcpm (100 cps)	6.3	12.6
Between 6 kcpm and 12 kcpm (200 cps)	4.2	8.4
More than 12 kcpm	2.1	4.2

Table 4.2: Response Time Based on Count Rate

The Model 3002 also utilizes a Step function in Auto Response mode, which enables faster response to a significant increase or decrease in Count Rate. When the instrument detects a sudden change in count rate from the detector, the response time is reduced to 1 second to quickly show the new value.

Operational Modes (Default 0 - All modes available) - A short press of MODE to adjust the value. Available values are:

- 0 - RATE, MAX and COUNT modes
- 1 - RATE and MAX Modes only
- 2 - RATE AND COUNT Modes only
- 3 - RATE Mode only

Count Time - A short press of ON/OFF to select the value to be adjusted, and MODE to adjust the value. Setting Count Time to 0 enables continuous count until reset. If 9 minutes are selected, then the maximum seconds value is 60; otherwise, the maximum seconds value is 59. Available values are:

- Ones Place (0-9)

- Tens Place (0-6, 6 only available if minutes value is 9)
- Hundreds Place (0-9)

Auto Shutdown Time (Default 0 - off) - A short press of MODE to adjust the value. Available values are:

- Ones Place (0-9) hours

Backlight Threshold - A short press of MODE to adjust the value. Available values are:

- LO - Backlight comes on at a higher ambient light level.

There are two different options for Backlight Threshold Low, which can be set through the software. Locate the parameters in the Dev tab. Enter the desired number into the "Value" field.

- Low Light Turn On - This value will set the threshold that the backlight will turn on at. (This should be lower than the Low Light Turn Off value.)
- Low Light Turn Off - This value will set the threshold that the backlight will turn off at. (This should be higher than the Low Light Turn On value).

- HI - Backlight comes on at a lower ambient light level.

There are two different options for Backlight Threshold High, which can be set through the software. Locate the parameters in the Dev tab. Enter the desired number into the "Value" field.

- High Light Turn On - This value will set the threshold that the backlight will turn on at. (This should be lower than the High Light Turn Off value.)
- High Light Turn Off - This value will set the threshold that the backlight will turn off at. (This should be higher than the High Light Turn On value).

- OFF - Disables backlight

4.7 Setup Page 2

RATE/MAX Units and Minimum Display (Default 0 cpm) - A short press of the ON/OFF to select the value to adjust, and MODE to adjust the value. Available values are:

- Number of Decimal Places (0, 1, or 2)
- Minimum Units - See List Below

cpm	kcpm	cps	kcps
dpm	kdpm	Bq	kBq

Table 4.3: Units and Multipliers

RATE/MAX Units Maximum Display (Default 999 kcpm) - A short press of ON/OFF to select the value to adjust, and MODE to adjust the value. Units will be the same as selected earlier with Units and Minimum Display. Available values are:

- Ones Place (0-9)
- Tens Place (0-9)
- Hundreds Place (0-9)
- Number of Decimal Places (0, 1, or 2)
- Range (k on/off for cpm, cps, dpm, Bq)

Count Units and Minimum Display (Default 0 c) - A short press of ON/OFF to select the value to adjust, and MODE to adjust the value. Available values are:

- Number of Decimal Places (0, 1, or 2)
- Minimum Units depend on the selected Primary Units. See list below.

Primary Units	Primary Count Units Available
cps kcps	cps c
cpm kcpm	cpm c
Bq kBq	Bq d
dpm kdpm	dpm d

Table 4.4: Count Units and Multipliers

Channel Display Selection (Default 0 - α , β , and $\alpha+\beta$) - A short press of MODE to adjust the value. Available values are:

- 0 - α , β , and $\alpha+\beta$ Channels
- 1 - α and β Channels only
- 2 - α and $\alpha+\beta$ Channels only
- 3 - β and $\alpha+\beta$ Channels only
- 4 - α Channel only

- 5 – β Channel only
- 6 – $\alpha+\beta$ Channel only

4.8 Setup Page 3

Alpha Efficiency (Default 20.0%) - A short press of the ON/OFF to select the value to adjust, and MODE to adjust the value. Available values are:

- Ones Place (0-9)
- Tens Place (0-9)
- Hundreds Place (0-9)
- Number of Decimal Places (0 or 1)

Normally the efficiency is used on a per detector basis or 4pi basis, i.e. the efficiency of the detector is calculated by dividing the count rate received from a source by the total disintegration rate of the source. When either dpm or Bq units are chosen, the use of the 4pi efficiency allows the display of the source size or activity on the Model 3002 display.

But if the user desires to have the Model 3002 show results in terms of dpm/100 cm², the user could manipulate the efficiency to produce this result by multiplying the efficiency times the ratio of the detector area to 100 cm². For example, using a detector with an area of 15 cm², if we start with 10% efficiency to measure in dpm, then the parameter could be changed to 1.5% to measure in dpm/100 cm².

Or likewise for Bq/cm², efficiency could be calculated as: efficiency = count rate/disintegration rate*detector area (in cm²). For example, with the same detector as above with an area of 15 cm², and starting with an efficiency value of 15%, then the parameter could be changed to 225% to measure in Bq/cm².

Alpha Pulser Threshold (Default 120 millivolts) - A short press of ON/OFF to select the value to adjust, and MODE to adjust the value. Available values are:

- Ones Place (0-9)
- Tens Place (0-9)
- Hundreds Place (0-9)

Alpha Pulser Window (Default 999 millivolts) - A short press of ON/OFF to select the value to adjust, and MODE to adjust the value. Set this Value to 000 or 999 to disable. Available values are:

- Ones Place (0-9)

- Tens Place (0-9)
- Hundreds Place (0-9)

Alpha RATE/MAX Mode Alarm Point (Default 5.00 kcpm) - A short press of ON/OFF to select the value to adjust, and MODE to adjust the value. Units will be the same as selected earlier with RATE/MAX Units (P2-1). The ALARM LCD segment will be on to indicate an alarm parameter. Set this Alarm Point to 000 to disable. Available values are:

- Ones Place (0-9)
- Tens Place (0-9)
- Hundreds Place (0-9)
- Number of Decimal Places (0, 1, or 2)
- Range (k on/off)



If the RATE/MAX Units has changed to a value other than that used to previously set this Alarm Point, the Alarm Point will be reset to 000.

Alpha Count Alarm Point (Default 5.00 kc) - A short press of ON/OFF to select the value to adjust, and MODE to adjust the value. Units will be the same as selected earlier with Count Units (P2-3). The ALARM LCD segment will be on to indicate an alarm parameter. Set this Alarm Point to 000 to disable. Available values are:

- Ones Place (0-9)
- Tens Place (0-9)
- Hundreds Place (0-9)
- Number of Decimal Places (0, 1, or 2)
- Range (k on/off)



If the COUNT Units has changed to a value other than that used to previously set this Alarm Point, the Alarm Point will be reset to 000.

Alpha Loss of Count Alarm Time (Default 600 seconds) - A short press of ON/OFF to select the value to adjust, and MODE to adjust the value. Setting the Loss of Count Alarm Time to 0 disables the alarm. Value is in seconds. Available values are:

- Ones Place (0-9)
- Tens Place (0-9)
- Hundreds Place (0-9)

4.9 Setup Page 4

Beta Efficiency (Default 15.0%) - A short press of the ON/OFF to select the value to adjust, and MODE to adjust the value. Available values are:

- Ones Place (0-9)
- Tens Place (0-9)
- Hundreds Place (0-9)
- Number of Decimal Places (0 or 1)

Normally the efficiency is used on a per detector basis or 4pi basis, i.e. the efficiency of the detector is calculated by dividing the count rate received from a source by the total disintegration rate of the source. When either dpm or Bq units are chosen, the use of the 4pi efficiency allows the display of the source size or activity on the Model 3002 display.

But if the user desires to have the Model 3002 show results in terms of dpm/100 cm², the user could manipulate the efficiency to produce this result by multiplying the efficiency times the ratio of the detector area to 100 cm². For example, using a detector with an area of 15 cm², if we start with 10% efficiency to measure in dpm, then the parameter could be changed to 1.5% to measure in dpm/100 cm².

Or likewise for Bq/cm², efficiency could be calculated as: $\text{efficiency} = \text{count rate} / \text{disintegration rate} * \text{detector area (in cm}^2\text{)}$. For example, with the same detector as above with an area of 15 cm², and starting with an efficiency value of 15%, then the parameter could be changed to 225% to measure in Bq/cm².

Beta Pulser Threshold (Default 3.5 millivolts) - A short press of ON/OFF to select the value to adjust, and MODE to adjust the value. Available values are:

- Ones Place (0-9)
- Tens Place (0-9)
- Hundreds Place (0-9)

Beta Pulser Window (Default 30.0 millivolts) - A short press of ON/OFF to select the value to adjust, and MODE to adjust the value. Set this Value to 000 or 999 to disable. Available values are:

- Ones Place (0-9)
- Tens Place (0-9)
- Hundreds Place (0-9)

Beta RATE/MAX Mode Alarm Point (Default 5.00 kcpm) - A short press of ON/OFF to select the value to adjust, and MODE to adjust the value. Units will be the same as selected earlier with RATE/MAX Units (P2-1). The ALARM LCD segment will be on to indicate an alarm parameter. Set this Alarm Point to 000 to disable. Available values are:

- Ones Place (0-9)
- Tens Place (0-9)
- Hundreds Place (0-9)
- Number of Decimal Places (0, 1, or 2)
- Range (k on/off)



If the RATE/MAX Units has changed to a value other than that used to previously set this Alarm Point, the Alarm Point will be reset to 000.

Beta Count Alarm Point (Default 5.00 kc) - A short press of ON/OFF to select the value to adjust, and MODE to adjust the value. Units will be the same as selected earlier with Count Units (P2-3). The ALARM LCD segment will be on to indicate an alarm parameter. Set this Alarm Point to 000 to disable. Available values are:

- Ones Place (0-9)
- Tens Place (0-9)
- Hundreds Place (0-9)
- Number of Decimal Places (0, 1, or 2)
- Range (k on/off)



If the COUNT Units has changed to a value other than that used to previously set this Alarm Point, the Alarm Point will be reset to 000.

Beta Loss of Count Alarm Time (Default 60 seconds) - A short press of ON/OFF to select the value to adjust, and MODE to adjust the value. Setting the Loss of Count Alarm Time to 0 disables the alarm. Value is in seconds. Available values are:

- Ones Place (0-9)
- Tens Place (0-9)
- Hundreds Place (0-9)

4.10 Setup Page 5

Datalogging Mode - Displays the current Datalogging Mode selection for the device. Valid values are 1 - 2.

Month - Displays the month of the Real Time Clock. Valid values are 1 - 12.

Day - Displays the day of the Real Time Clock. Valid values are 1 - 31.

Year - Displays the decade and year of the Real Time Clock. Valid values are 00 - 99.

Hour - Displays the hour of the Real Time Clock. Valid values are 0 - 23.

Minute - Displays the minutes of the Real Time Clock. Valid values are 00 - 59.

Seconds - Displays the seconds of the Real Time Clock. Valid values are 00 - 59.

DATALOGGING

The datalogging feature of the Model 3002 allows the user to log radiation readings with the use of a handle-mounted LOG button. Data can be logged in any of the Model 3002's operational modes (RATE, MAX, and COUNT). Up to 1000 data points can be taken and stored internally. Depending on the chosen Datalogging Mode, the user can quickly save logged data using a single Location ID, or select from up to 250 stored Location IDs. A Real Time Clock (RTC) is utilized to time and date stamp each datalog entry.

The saved log data and stored location IDs can be viewed, downloaded, and erased using the LMI Lumic Datalogger software kit, which includes a USB cable. Editing of datalogging parameters and RTC via setup mode on the instrument is disabled.

Setup of the datalogging parameters is also done through the LMI Lumic Datalogger software. The advanced user or administrator can set:

- Datalogging Mode
- Real Time Clock (RTC) Values
- Location IDs

5.1 Datalogging Operation – Mode 1

Datalogging Mode 1 will store the logged data using only the first Location ID in the Location ID table.

- When the LOG button is pressed, the current radiation reading and other log data is saved along with the first Location ID in the format specified in the Specifications at the end of this section.
- In COUNT Mode:
 - During a count , the LOG button is disabled until completion of a Scaler count.
 - For a continuous Scaler count (Scaler time is 0), the LOG button is enabled at all times.

- For approximately 2 seconds, the LCD will display the Datalog Table index for the newly saved log data.



Figure 5.1: Displaying Datalog Table Index of 12

- After displaying the Datalog Table index, the instrument will return to the previous mode of operation.
- The Datalog Table is linear; once the table is full, no further writes will be allowed until the Datalog Table is erased.
- If an attempt is made to write to a full Datalog Table, several 1/4 second audio alerts will sound and the maximum Datalog Table index (1.00 k) will be displayed for about 2 seconds. The instrument will then return to the previous mode of operation.

5.2 Datalogging Operation – Mode 2

Datalogging Mode 2 will allow the user to choose the Location ID (by Location ID Table index) to store with the logged data.

- When the LOG button is pressed, the current radiation readings and other log data are temporarily stored.
- In COUNT Mode:
 - By default, Mode 2 is disabled during a count; instead, the datalogging feature functions as it would in Mode 1.
- The LCD display will show a possible Location ID Table index for the user. The index will be auto-incremented from the previously used index.

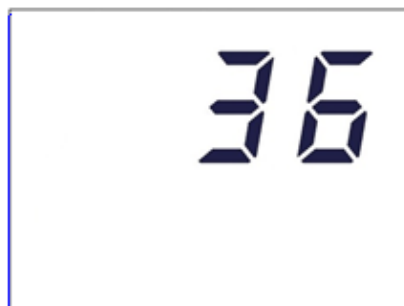

Figure 5.2: Displaying Datalog Location ID Table Index of 36

- The number will be blinking, indicating a changeable value. The user may then enter the preferred Location ID Table index by a short press of the MODE (to increment the value) as in Setup mode.
- Once the user has the preferred Location ID Table index entered, a short press of the LOG button will save the log data.
- After displaying the Datalog Table index, the instrument will return to the previous mode of operation.
- The Datalog Table is linear; once the table is full, several 1/4 second audio alerts will sound and the maximum Datalog Table index (1.00 k) will be displayed for about 2 seconds, and no further writes will be allowed until the Datalog Table is erased.

5.3 Data Log Operation

- **LOG Button:** handle-mounted
- **Clock:** Real Time Clock
- **Location ID Storage:** internal storage of up to 250 32-byte location IDs
- **Datalog Record Storage:** internal storage of up to 1000 64-byte datalog records

5.4 Format

The datalogging format is as follows:

- Format Version (1 Byte)
- Month (1 Byte)
- Year (2 Bytes)
- Day (1 Byte)
- Hour (1 Byte)
- Minutes (1 Byte)
- Seconds (1 Byte)
- Alpha Logged Value (4 Bytes)
- Beta Logged Value (4 Bytes)
- Alpha Range (1 Byte)
- Beta Range (1 Byte)

- Units (1 Byte)
- Mode (1 Byte)
- Detector Number (1 Byte)
- Status (1 Byte)
- Reserved (2 Bytes)
- Elapsed Count Time in seconds (4 Bytes)
- Count Mode Time in seconds (4 Bytes)
- Location ID (32 Bytes)

SOFTWARE

6.1 Connecting to Software

The Model 3002 software is sent with a standard two-meter cable. (A five-meter cable can be provided if requested. However, any cable longer than two meters may have issues with some USB hubs and computers, typically laptops.)

To connect an instrument to the computer, please connect one end of the USB cable to the instrument first, and then the other end to the computer. Do not connect both ends to the computer.

Please allow Windows® a moment to install the proper HID drivers for the instrument before trying to use any software.



We recommend that you plug the USB cable into the back of your PC that connects to your motherboard instead of a USB hub.



Some parameters may only be edited in software, such as the backlight thresholds, COUNT Display Mode, COUNT Audio Mode, and Setup prtct.

Follow the Lumeric 2 software manual.

ADVANCED FEATURES

7.1 Software Calibration Tools

Lumic Calibration software includes wizards that will assist in calibrating and plateauing detectors. After configuring the wizard for a specific detector, the wizard will automate much of the data collection and calculation required for calibration.

7.2 Instrument Calibration

This instrument provides the ability to digitally enter a voltage for both high voltage and threshold. As such, the instrument itself needs to be calibrated. This happens at the factory when the instrument is built and should not require re-calibration. However, if calibration is required (due to board rework, etc.) the calibration settings are available in Lumic Calibration software.

7.3 Other Device Data

The following parameters on the instrument allow recording import device information within the device:

Firmware Version: This is a read-only presentation of the firmware version. With a firmware version of Ex.y.zzzz, the Ex.y will show up on the device screen during the power-on sequence and signifies the released version.

Device – Model Name: This should match the model name on the front face of the instrument.

Device – Serial Number: This should match the serial number of the instrument.

Detector – Model: This can store the model of the detectors the instrument was calibrated for.

Detector – Serial Number: This can store the serial number of the detectors the instrument was calibrated for.

7.4 Battery Life

The instrument leaves the shop with adjustments to meet most consumer demands; however, advanced users may use the Lumic software to adjust the LED and backlight brightness to maximize battery life. By changing the backlight mode of operation and adjusting the brightness settings for the backlight and LED to meet user needs, it is possible to reduce battery current consumption by as much as 50%.

7.5 Real-time Streaming

Lumic Calibration 2.0 software and this instrument have the ability to stream data from the instrument to a computer. The data can be viewed live inside software or can be recorded in a file.

Multiple user-selected parameters can be streamed simultaneously including:

- Remote display of the screen
- All unit values
- Device status
- Live HV current measurement

7.6 Button Mapping

By default, the LOG button's primary purpose is to take a log of the current display or initiate a count, in COUNT mode, and log the result upon completion assuming data logging is enabled. Lumic Calibration 2.0 software allows the LOG button to be configured (this is referred to as button mapping) to perform a number of features. In some cases, the available features are only useful for a particular function. As a result, the LOG button can be mapped for RATE/MAX modes and COUNT mode separately.

Using the Lumic Calibration 2.0 software, the user can select among the following features which can be mapped to the short press, long press, and extra-long press of the LOG button.

- Do Nothing - This button press has no effect. This the default configuration for a long press and an extra-long press of the LOG button.
- Take Log - Log the current display or initiate a count in COUNT mode and log the results upon completion (assuming data logging is enabled). This is the default configuration for a short press of the LOG button.
- Change Units - Changes to the next available radiation type. This is similar to a short press of the $\alpha - \beta$ button.
- Toggle Click Audio - Changes the audio level. This is similar to a short press of the AUDIO button.

- Change Modes - Changes to the next available mode of operation. This is similar to a short press of the MODE button.
- Toggle Count Display (COUNT mode only) - In COUNT mode, if the count is active, this will switch between the count timer and the count display. This is similar to the extra-long press of the $\alpha - \beta$ button in COUNT mode. This has no effect in RATE/MAX modes and should not be used in RATE/MAX button mapping.
- Reset Rate (RATE/MAX mode only) - This will reset the currently displayed rate. This has no effect in COUNT mode.
- Advance Count Mode (COUNT mode only) - In COUNT mode, if the count is ready then the button will initiate a count without logging the results upon completion. If the count is in process, the count will be stopped and the count timer will be reset. If the count has concluded, the count timer will be reset.
- Do Nothing - This button press has no effect. A repeat of the aforementioned 'Do Nothing', this feature supports backwards compatibility with previous versions of firmware previously released with button mapping capability.

7.7 CPS Offset

Using the Lumic Calibration 2.0 software, the user can enter a CPS Offset for a given channel. The CPS Offset is counts per second which are subtracted from the channel reading's base counts before any deadtime correction or unit conversion is applied. This is a useful method by which to perform background subtraction in a controlled environment.



The instrument does not calculate the CPS Offset for the user. The CPS Offset is a fixed value which must be configured while the instrument is connected to the Lumic Calibration 2.0 software and which is stored in the instrument and reused each time the instrument is powered on.

By default, CPS Offset is 0 and no count subtraction is performed.

SAFETY CONSIDERATIONS

8.1 Environmental Conditions for Normal Use

Indoor or outdoor use (While rain resistant, user is cautioned to avoid getting water through detector opening.)

No maximum altitude

Temperature range of -20 to 50 °C (-5 to 122 °F), may be certified for operation from -40 to 65 °C (-40 to 150 °F)

Maximum relative humidity of less than 95% (non-condensing)

Pollution Degree 3 (as defined by IEC 664): (Occurs when conductive pollution or dry nonconductive pollution becomes conductive due to condensation. This is typical of industrial or construction sites.)

Not certified for use in an explosive atmosphere

8.2 Warning Markings and Symbols

The Model 3002 Survey meter is marked with the following symbols:



CAUTION (per ISO 3864, No. B.3.1): designates hazardous live voltage and risk of electric shock. During normal use, internal components are hazardous live. This instrument must be isolated or disconnected from the hazardous live voltage before accessing the internal components. This symbol appears on the side panel. Be sure to take the precautions noted in the next section whenever necessary.



The “crossed-out wheeie bin” symbol notifies the consumer that the product is not to be mixed with unsorted municipal waste when discarding. Each material must be separated. The symbol is placed on the label located on the side panel. See section 10, “Recycling,” for further information.



The “CE” mark is used to identify this instrument as being acceptable for use within the European Union.



Caution!

The operator or responsible body is cautioned that the protection provided by the equipment may be impaired if the equipment is used in a manner not specified by Ludlum Measurements, Inc.

8.3 Cleaning and Maintenance Precautions

The Model 3002 may be cleaned externally with a damp cloth, using only water as the wetting agent.

Observe the following precautions when cleaning or performing maintenance on the instrument:

- Turn the instrument OFF and remove the batteries.
- Allow the instrument to sit for one minute before cleaning the exterior or accessing any internal components for maintenance.

REVISION HISTORY



This section of the manual will be updated with each revision of the Model 3002 in order to document changes over time. Ludlum Measurements' policy is to provide for free, the latest firmware release for an instrument for the life of that instrument. Note that not all new firmware features will be available for older instruments due to hardware design changes. If this is the case, it will be noted in the manual.

December 2015: New manual.

July 2017: Added front-panel drawing to front of manual, updated firmware and added information about long press/short press when dealing with button selections, added Device Rate Rest button, added Count Mode Audio and Count Mode displays, added P5 date and time parameters to Default Setup Values table on page 4-2, changed mentions of ON/ACK to ON/OFF, changed references of Triad to Lumic.

April 2018: Added note to page 2-11 regarding log button actions when datalogging is disabled. Corrected part # for unimorph with harness and added part # for HV Shield in Standard Parts List Section 9.

September 2018: Changed IP rating from 65 to 53 in Specifications, per further testing.

February 2019: Main Board was changed from 5519-063 to 5519-270 in order to replace capacitors causing HV noise.

September 2019: Corrected NEMA rating from 4x to 5 in Section 3 Specs page 3-2.

October 2021: New manual format. Firmware updated to version n20, which re-enables many features not available in n11. In Chapter 1: Introduction, added information about when settings are protected and a reference to Appendix A. Modified Chapter 2: COUNT Mode Operation to explain predefined count times and proper operation, also added Section 2.4.1 Detector Loss of Count and added Log Button on page 18. In Chapter 3: Specifications, added "two alarms" to Alarms; added Dead Time Correction and Overrange; under User Controls added the Log Button; Audio changed from 80 db to 72 db; and added Headphone Jack. In Chapter 4: Setup Mode, added default values on the Setup Parameters table for P3-

4 through P3-6 and P4-4 through P4-6. P5-1 Datalogging is no longer listed as "optional." In Chapter 5: Datalogging in Sections 5.1 and 5.2, changed Scaler Mode to Count Mode; replaced Specifications section with Section 5.3 Data Log Operation and 5.4 Format. Added Chapter 6: Software. Added Chapter 7: Advanced Features. Added Chapter 11: Options. Added Appendix A: Auxiliary Communications.

December 2021: Add references to Bluetooth. Firmware updated to version n20 to address new board designs. Added explanation of feature to identify the board installed in the instrument. Clarified the audio alert which occurs when the data log buffer is full. Corrected the beep description associated with button presses. Added clarification of the delay related to searching log record size on power-up.

February 2022: Changed main board part number to newest version. Updated Lmic Calibration Kit part number.

RECYCLING

Ludlum Measurements, Inc. supports the recycling of the electronics products it produces for the purpose of protecting the environment and to comply with all regional, national, and international agencies that promote economically and environmentally sustainable recycling systems. To this end, Ludlum Measurements, Inc. strives to supply the consumer of its goods with information regarding reuse and recycling of the many different types of materials used in its products. With many different agencies – public and private – involved in this pursuit, it becomes evident that a myriad of methods can be used in the process of recycling. Therefore, Ludlum Measurements, Inc. does not suggest one particular method over another, but simply desires to inform its consumers of the range of recyclable materials present in its products, so that the user will have flexibility in following all local and federal laws.

The following types of recyclable materials are present in Ludlum Measurements, Inc. electronics products, and should be recycled separately. The list is not all-inclusive, nor does it suggest that all materials are present in each piece of equipment:

Batteries	Glass	Aluminum and Stainless Steel
Circuit Boards	Plastics	Liquid Crystal Display (LCD)

Ludlum Measurements, Inc. products that have been placed on the market after August 13, 2005, have been labeled with a symbol recognized internationally as the “crossed-out wheelie bin,” which notifies the consumer that the product is not to be mixed with unsorted municipal waste when discarding. Each material must be separated. On the instrument, the symbol will be placed on the serial number label located on the side of the instrument.

The symbol appears as such:



OPTIONS

Lumic Calibration Kit (part # 4519-865): The kit includes calibration software plus the cable required for calibration. The software allows users to collect data and read, print, and save device parameters. It allows administrators to adjust device parameters.

Lumic Datalogging Kit (part # 4498-1019): The kit includes datalogging software plus the required cable. The software allows users to collect data and read, print, and save device parameters. It allows administrators to adjust device datalogging parameters.

Headphone Jack (part # 4498-555): This provides the Model 3000 series of instruments with a jack and circuitry required for a standard headphone plug. Ludlum Measurements also offers mono/stereo headphones with volume control.

Headphones (part # 22-9313): This is a set of adjustable stereo/mono headphones.

Shoulder Strap (part # 4498-868): This adjustable, padded strap comes with a kit to attach it to a Model 3000 series instrument.

Protective Storage/Transport Case (part # 2312958): This is a medium-sized, foam-padded, rugged case that can be secured with a padlock. It is fitted with a manual pressure relieve valve for air transport, providing water and dust-proof protection for sensitive instruments.



Each instrument may only be configured with one of the following options. The options listed are not available on all instruments. Contact your sales rep or LMI for details.

Bluetooth 4.0 LE® (Bluetooth Low Energy, sometimes referred to as Bluetooth Smart) (part # 4519-564): This feature permits wireless transmission of readings from a connected instrument, allowing operators to remotely monitor the live data on the screen of their mobile device. When paired with Ludlum's Lumic Linker App, the operator can also seamlessly send data to the *RadResponder Network, which provides a central location for up-to-date information from operators in the field. Reported data includes user, radiometric survey, survey notes, and GPS location, as well as details about the instrument and detector being used. (See the Model 3000 Series Bluetooth LE® Addendum for more details on how to use this option.)

RS-232 Serial Port (part # 4519-490): This option adds a true RS-232 serial port connector.

TTL Serial Port: (part # 4519-155): This option adds a TTL 3.3 V serial port connector.

Available modes are instrument independent. Contact LMI for more information on configuration options.

STANDARD PARTS LIST

Part Description	Part Number
Model 3002 Digital Survey Meter	48-4037
Model 3002 Main Board	5519-797
Model 3002 Bezel Assembly	4498-881
Model 3002 Main Keypad Membrane Switch	7498-877
HV Shield	7498-996
Model 3000 Battery Holder Modified	7498-458
Model 3000 Unimorph with Harness	8498-542-01
LCD 82 mm x 61.64 mm	7498-417

Table 12.1: Standard Parts List

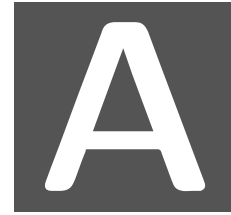

AUXILIARY COMMUNICATIONS

A.1 AuxCom Overview

AuxCom, short for Auxiliary Communications, is a feature included on certain Ludlum instruments. An AuxCom port allows the instrument to expand its capabilities with a variety of external devices through a standard serial interface.

A.2 Requirements

In order to take advantage of the AuxCom functionality, you will need the following:

- A serial or RS-232 serial option
- A wiring harness to connect the target device
- The correct mode set for the AuxCom port

A.3 Usage

Usage of the AuxCom port is generally very simple from the user's perspective. Most modes initialize everything to be plug-n-play; however, there are a couple of caveats.

If using the SLURM protocol, the user will need to pair the instrument with a mobile device using the hot key listed below.

A.3.1 AuxCom Usage - Hot Key

There are two types of hot-key presses:

PIN Generation: If the $\alpha - \beta$ and MODE buttons are both held for longer than 2 seconds (2 beeps), the instrument will present the user with a PIN needed for pairing. Repeat the process to clear the screen.

Enable: If the $\alpha - \beta$ button and MODE buttons are both held for longer than 1 second (1 beep), the AuxCom port will toggle on and off each time this is done. Off or On will appear on the screen to indicate the current AuxCom state.



The pairing PIN is only used for SLURM.

A.3.2 AuxCom Usage - Pairing

“Pairing” is the process to connect an instrument with a mobile device. It helps verify you are connecting to the correct device, as well as configures the encryption. The pairing process should only be done when both the instrument and mobile device are ready. Ensure the App or software is installed, and then follow these steps:

1. Open connection window in App/Software.
2. Use 2-second PIN hot key to get PIN.
3. Use 2-second PIN hot key to clear screen.
4. Use 2-second Enable hot key to turn on WiFi.
5. Select “Scan” in App/Software.
6. When instrument is found by mobile device, select device in list and then “Pair.”
7. Enter PIN in App/Software from Step 2.

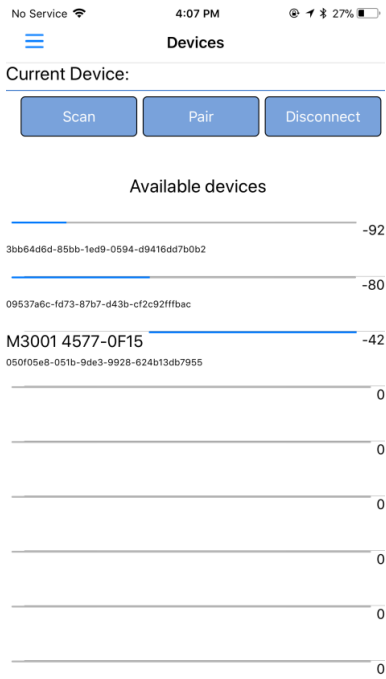

Figure A.1: Example – Device Selection In Lumic Linker App (iOS)

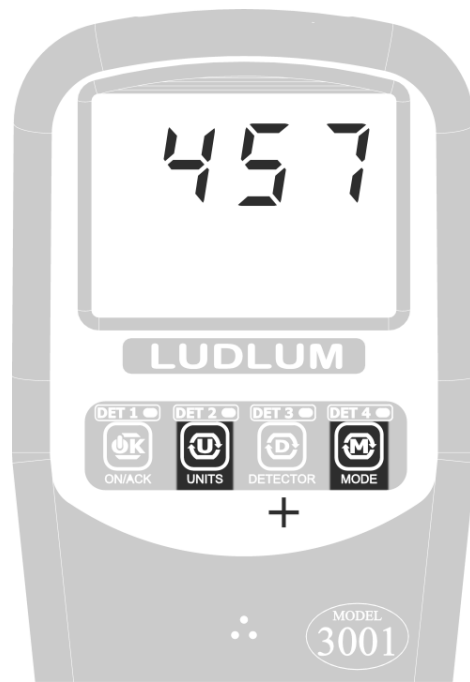

Figure A.2: Example – Pairing

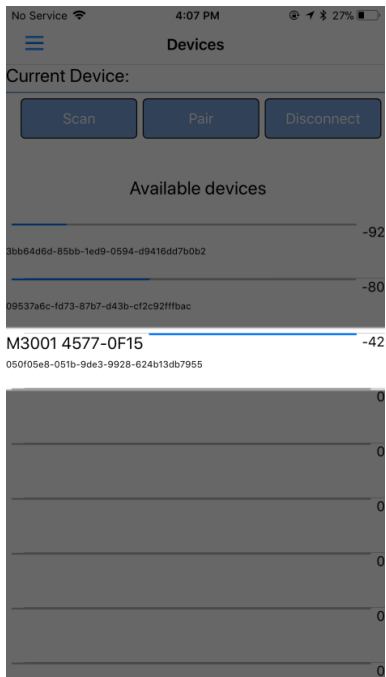

Figure A.3: Example – Model 3000 series Found in Lumic Linker App (iOS)

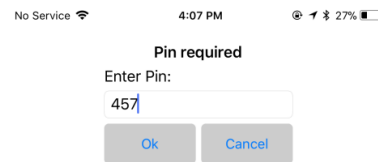

Figure A.4: Example – Entering PIN In Lumic Linker App (iOS)

A.4 Settings

The settings for AuxCom are only configurable through software. See A.5.

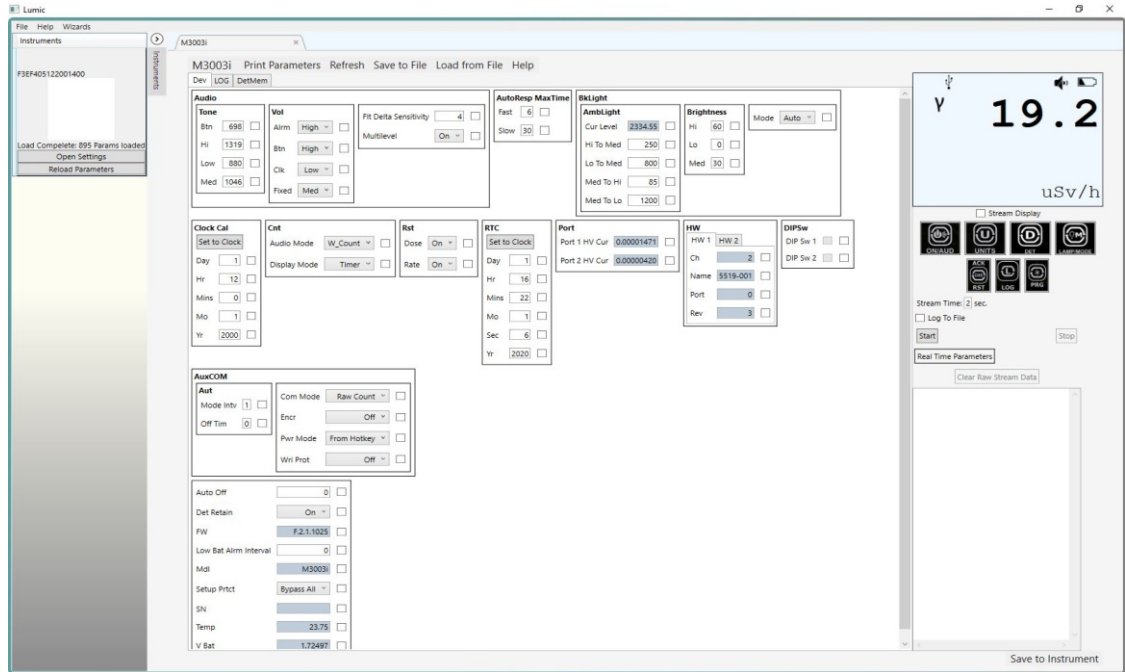

Figure A.5: Example – Lumic 2.0 Calibration Software

A.4.1 AuxCom Setting - Mode

The mode setting for AuxCom configures how the port will function. The table below lists the modes and their baud rates.

Mode	Baud Rate
SLURM	115200
LMI Direct	115200
Raw Count	115200

Table A.1: AuxCom Mode

SLURM: Used to encapsulate “LMI Direct” messages with encryption and checksums. This mode is primarily used for Bluetooth®.

LMI Direct: Full exposure to the “LMI Comm” Communication protocol. This allows reading and writing all parameters, data streaming, etc.

Raw Count: Mode that automatically transmits raw, uncorrected counts. The count interval is based on the AuxCom Auto Mode Interval variable. The output value is the cumulative counts that occurred in the previous interval on all enabled channels.

A.4.2 AuxCom Setting - Off Time

This setting defines the number of minutes the AuxCom port will sit idle before turning off. The primary use for this parameter is to save power while using Bluetooth® by turning off

the Bluetooth® module if there is no connection. The table below shows valid settings.

Setting	Description
0	Disabled
1-9	Inactivity minutes before auto off

Table A.2: AuxCom Auto Off Time

A.4.3 AuxCom Setting - Pwr Mode

This setting determines whether or not the AuxCom module is turned on when the instrument is powered on. In addition to power savings, this setting is also intended for use when a user has a need for “radio silence” (no RF broadcasts). This setting does not override the hot key function. Again, the primary use for this parameter is while using Bluetooth®. The table below shows valid settings.

Description
From Hotkey
At Boot

Table A.3: AuxCom Power on at Boot-up

A.4.4 AuxCom Setting - Write Protect

This setting is an additional security measure that prevents commands that would modify parameters from being executed over the AuxCom port. While using the instrument equipped with a wireless radio, such as the Bluetooth® module, there is the potential for the instrument becoming mis-configured, inadvertently or intentionally, from a remote location. This setting is meant to ensure that cannot happen. The table below shows valid settings.

Setting	Description
0	AuxCom Write Protect Disabled
1	AuxCom Write Protect Enabled

Table A.4: AuxCom Write Protect



If write protect is enabled, it can only be disabled by physically connecting it to the instrument through the USB port.

A.4.5 AuxCom Setting - Encryption

This setting controls whether or not encryption is enabled on the AuxCom port. While using the instrument equipped with a wireless radio, such as the Bluetooth® module, there is the potential for external eavesdropping or attack from a third party. By utilizing an industry standard encryption, this becomes much more difficult. The table below shows valid settings.



This setting only applies to SLURM mode.

Setting	Description
0	AuxCom Encryption IS NOT used
1	AuxCom Encryption IS used

Table A.5: AuxCom Encryption



SLURM mode will still require the “pairing” sequence to connect to the instrument.

A.4.6 AuxCom Setting - Auto Mode Interval

This setting controls the number of seconds for each transmitted value in automatic stream modes. The table below shows valid settings.



This setting only applies to Raw Counts mode as of this writing.

Setting	Description
0	As fast as possible (1/4 second on Model 3000 series)
1-255	n-Seconds

Table A.6: AuxCom Auto Mode Interval